

HYDRA-DI DEIONIZED WATER SYSTEMS

KEY FEATURES

- WALL MOUNTED AND LOW PROFILE
- LOW RESISTIVITY INDICATING LIGHT
- ECONOMICALLY PRODUCES DI WATER

HYDRA-DI SYSTEM

The Hydra DI Series is a pre-assembled cartridge system that provides deionized water using a staged filtration process. Water purification is provided using a 3-step process. Stage (1) removes particles greater than 5 micron, chlorine, and organics. Stages (2 & 3) are deionizers designed to remove dissolved minerals. The Hydra DI series includes all cartridges and resistivity light for a total turnkey system.

The Hydra DI high purity system uses low odor mixed bed cartridges for applications requiring better than 10 MegOhm water quality. For less corrosive applications, the Hydra DI high capacity configuration provides water quality better than 50 KiloOhms. This is ideal for scale reduction and non-stainless steel piping systems.

APPLICATIONS

HIGH CAPACITY DI HYDRA -

Environmental chambers, sterilizers, ultrasonic cleaners, chiller loops.

HIGH PURITY DI HYDRA -

General deionization, battery water Filling, humidification, hydrogen generator, glassware rinse, glassware washer, sterilizers.

FEATURES & BENEFITS

- TURN-KEY SYSTEM FOR LOW COST – ON DEMAND SERVICE
- RESISTIVITY LIGHT INCLUDED FOR VISUAL INDICATION OF CARTRIDGE REPLACEMENT
- AVAILABLE IN HIGH PURITY AND HIGH CAPACITY CONFIGURATIONS
- DESIGNED FOR CITY WATER & TAP WATER SUPPLY
- AVAILABLE IN 2-1/2" AND 4-1/2" DIAMETER (BIG BLUE STYLE) CONFIGURATIONS
- OUTLET ISOLATION VALVE, SPANNER WRENCH, AND ASSOCIATED TUBING PROVIDED

HYDRA-DI SYSTEMS AND ACCESSORIES



HYDRA HY-122-DI



HYDRA HY-122B-DI



2.5" CARTRIDGE REPLACEMENT KIT



4.5" CARTRIDGE REPLACEMENT KIT

HYDRA-DI - DEIONIZED WATER SYSTEM

TECHNICAL DATA

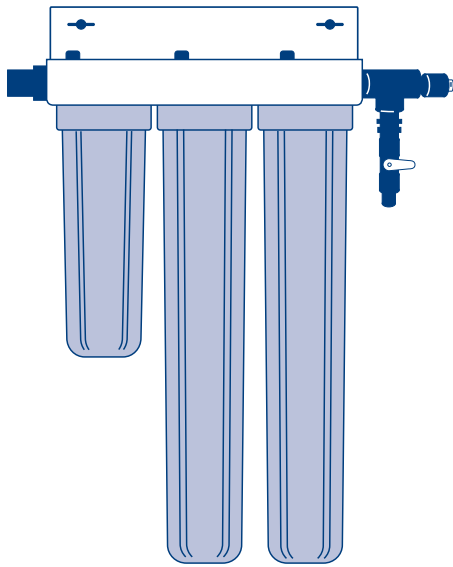

Dimensions (H x W x D)

24 in. x 20 in. x 6 in.
24 in. x 36 in. x 9 in.

Bowl Diameter

2 1/2" or 4 1/2"

Connections

Inlet - 3/8" O.D. Tubing
Outlet - 1/2" Hose Barb

Pressure

10 PSIG Minimum
100 PSIG Maximum

Temperature (Max.)

100 °F

Resistivity Light

200 KΩ or 50 KΩ

Voltage

120 Volts

Filter Housing

Polypropylene

Bracket

Painted Steel

HYDRA DI CAPACITY (GALLONS)

FEEDWATER Total Dissolved Solids (TDS as CaCO ₃)	HIGH PURITY (Better than 10 Megohm)		HIGH CAPACITY (Better than 50 Kohm)	
	HY-122-DI	HY-122B-DI	HY-122-DI-HC	HY-122B-DI-HC
10 ppm*	2,650	6,800	3,000	8,000
100 ppm	265	680	300	800
300 ppm	90	225	100	265
500 ppm	50	135	60	160

* Typical water quality with reverse osmosis pretreatment

ORDERING GUIDE

PART NUMBER	DESCRIPTION	FILTER TECHNOLOGY	BOWL DIAMETER	RESISTIVITY LIGHT	SHIPPING WEIGHT
HY-122-DI	High Purity 3 Stage Deionization System	(1) 10" Carbon Block (2) 20" High Purity	2.5"	200 KΩ	24 lbs.
HY-122B-DI	High Purity 3 Stage Deionization System	(1) 10" Carbon GAC (2) 20" High Purity	4.5"	200 KΩ	55 lbs.
HY-122-DI-HC	High Capacity 3 Stage Deionization System	(1) 10" Carbon Block (2) 20" High Capacity	2.5"	20 KΩ	24 lbs.
HY-122B-DI-HC	High Capacity 3 Stage Deionization System	(1) 10" Carbon GAC (2) 20" High Capacity	4.5"	20 KΩ	55 lbs.

SPECIFICATIONS

PART NUMBER	MEDIA FILL	DIMENSIONS (H X W X D)	FLOW RATE	TOTAL CAPACITY GRAINS AS CaCO ₃	TYPICAL EFFLUENT
HY-122-DI	High Purity	25"x 20"x 6	0.5 gpm	1,800	10 MΩ-cm
HY-122B-DI	High Purity	26"x 29"x 9	1.25 gpm	4,760	10 MΩ-cm
HY-122-DI-HC	High Capacity	24"x 20"x 6	0.5 gpm	2,160	50 KΩ-cm
HY-122B-DI-HC	High Capacity	26"x 29"x 9	1.25 gpm	5,710	50 KΩ-cm

CARTRIDGE REPLACEMENT KITS

PART NUMBER	FITS HYDRA MODEL	DESCRIPTION	CONTENTS	SHIPPING WEIGHT
HYK-001	HY-122-DI	High Purity Cartridge Replacement Kit	(1) 2.5" x 10" Carbon Block (2) 2.5" x 20" Mixed Bed	8 lbs.
HYK-002	HY-122B-DI	High Purity Cartridge Replacement Kit	(1) 4.5" x 10" Carbon GAC (2) 4.5" x 20" Mixed Bed	21 lbs.
HYK-009	HY-122-DI-HC	High Capacity Cartridge Replacement Kit	(1) 2.5" x 10" Carbon Block (2) 2.5" x 20" High Capacity	8 lbs.
HYK-010	HY-122B-DI-HC	High Capacity Cartridge Replacement Kit	(1) 4.5" x 10" Carbon GAC (2) 4.5" x 20" High Capacity	21 lbs.

REPLACEMENT RESISTIVITY LIGHTS

PART NUMBER	DESCRIPTION	SHIPPING WEIGHT
CL-20K-50	20 Kohm Resistivity Light	1 lb.
CL-200K-50	200 Kohm Resistivity Light	1 lb.
CL-2MG-50	2 Megohm Resistivity Light	1 lb.

MADE IN USA

PROUD TO BE
ISO 9001: 2015 CERTIFIED



Notes: Ordering information subject to change without notice. Please verify all specifications prior to ordering.

To place an order call (856) 626-1550 or e-mail ariescs@ariesfilterworks.com

IMPORTANT NOTICE TO USER:

The following is made in lieu of all other warranties expressed or implied. Manufacturer's and Seller's only obligation shall be to issue credit against the purchase or replacement of the equipment proved to be defective in material or workmanship. Neither Manufacturer nor Seller shall be liable for any injury, loss or damage, direct or indirect, special or consequential, arising out of the use of, misuse, or the inability to use such product. The information contained herein is based on technical data and tests which we believe to be reliable and is intended for use by persons having technical skill at their discretion and risk. Since conditions of use are outside ResinTech's control, we can assume no liability whatsoever for results obtained or damages incurred through the application of the data presented. This information is not intended as a license to operate under, or a recommendation to infringe upon, any patent of ResinTech's or others covering any material or use. The foregoing may not be altered except by written agreement signed by officers of the manufacturer.

DS-LPHydraDI-rev2.1